

User Manual

SNMP Module

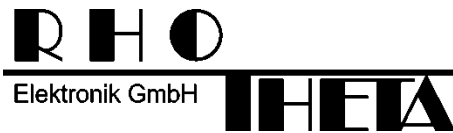

Edited by:

RHOTHETA Elektronik GmbH
Dr.-Ingeborg-Haeckel-Str. 2
82418 Murnau
Germany

Tel.: +49 8841 4879 - 0
Fax: +49 8841 4879 - 15

Internet: www.rhotheta.de
E-Mail: email@rhotheta.de

*Copyright © RHOTHETA Elektronik GmbH
All rights reserved
Issue: [2018/11/29] [Rev 1.00]
Document-ID: 12-9-2-0031-3-1-60*

Note:

The manufacturer reserves the right on making modifications of the product described herein at any time and without previous information.

Index

1	Legend of Signal Words	4
2	Safety	4
2.1	General Safety Information.....	4
2.2	Basic Safety Instructions	5
3	General Description	6
4	Installation	7
4.1	Hardware Connection for One Channel Mode	7
4.2	Hardware Connection for Multichannel Mode	9
4.3	Interfaces	10
4.4	Software Installation and Configuration.....	11
4.4.1	Mandatory Configuration	11
4.4.2	I/O Configuration Example.....	18
5	Operation	24
5.1	One Channel Mode.....	24
5.2	Multichannel Mode.....	24
6	Technical Characteristics	25
7	Legal Information	26
7.1	EU Declaration of Conformity	26
7.2	Disposal within the European Union.....	26
7.3	Disposal outside the European Union	26
8	Appendix	27
8.1	Test Example	27
9	Notes	30

1 Legend of Signal Words

Note

This symbol designates tips or additional notes that must be paid attention to and make work easier.

Caution

means that ignoring the instructions may lead to property damage or loss of data.

Warning

means that ignoring the instructions, there may be a danger to health or life.

2 Safety

2.1 General Safety Information

RHOTHETA Elektronik GmbH is constantly trying to keep the safety standard of the products up to date and to offer the customers the highest possible level of safety.

RHOTHETA products are designed and tested in accordance with the valid safety regulations. The compliance with these standards is continuously monitored by our quality assurance system.

This product is tested and left the factory in perfect technical and safety-relevant condition. To maintain this condition and to ensure safe operation, the user must pay attention to all instructions and warnings given. For any questions regarding these safety instructions, RHOTHETA Elektronik GmbH can be contacted at any time.

The observance of the safety instructions will help to prevent personal injury or damage caused by all kinds of dangers. This requires that the following safety instructions must be read carefully and understood before using the product, as well as observed when using the product. The additional safety instructions such as for protecting persons appear in relevant parts of the product documentation and must also be paid attention to.

The use of this product other than it's designated purpose or in disregard of the instructions of the manufacturer is the responsibility of the user. The manufacturer takes no responsibility for the misuse of the product.

The manufacturer is not liable beyond the scope of legal rules!

This guide is part of the product SNMP Module and is retained throughout the lifetime and to pass with the product.

2.2 Basic Safety Instructions

Caution / Warning**Read and observe the following instructions, warnings and safety instructions of the manufacturer!**

- At all work, the local or national safety and accident prevention regulations must be observed.
- The product may only be installed by authorized personnel. When installing or operating with the product always follow the manufacturer's instructions.
- Do place the product on appropriate locations.
- Do not expose the product environmental conditions (heat, humidity, wind load etc.) that exceed the specified conditions in the manuals.
- Use only the manufacturer prescribed components and/or use only recommended material and do not change this. Any other use or unauthorized modifications to the product will void the authorization to operate it.
- Connect only approved accessories kits or additional equipment.
- Ensure that the connections with information technology equipment, e.g. industrial computers, comply with the IEC 60950-1/EN 60950-1 standard that applies in each case.
- The product may only be opened by authorized personnel. The power connector must always be disconnected before opening.

3 General Description

SNMP Module is an optional hardware that provides the remote error monitoring of RHOTHETA RT-1000 direction finder systems over the Simple Network Management Protocol.



Figure 1: SNMP Module for One Channel RT-1000

The SNMP Module can be run in two modes (s. chapter 5):

- One Channel Mode
- Multichannel Mode

Basically the SNMP module consists of the:

1. EMD (Error Monitoring Device) (s. Figure 2, No. 3)
2. MOXA ioLogik E2210 (s. Figure 2, No. 2)
3. Power supply unit (s. Figure 2, No. 1)

The EMD is connected to the RT-1000 direction finder and receives the DF error status over the RS232 data protocol. If an error occurs, the error-information is provided from the EMD to the MOXA ioLogik E2210, which reports the error to the connected controller workstation (PC) as an SNMP trap over LAN. The case of an EMD module failure will be reported as well.

In case of RT-1000 Multichannel one EMD is connected to and associated with one of the DF-Channels (s. chapter 4.1). Up to 8 DF-Channels can be connected to one MOXA ioLogik E2210 device.



Figure 2: SNMP Module for RT-1000 Multichannel mounted on the 48.5 cm rack

4 Installation

4.1 Hardware Connection for One Channel Mode

Warning

Any handling on the wiring must be carried out by authorized personnel.
Always disconnect the power plug before any modification of the wiring.

Besides the SNMP Module itself the packing list of SNMP Module for "RT-1000 C" or "RT-1000 A" consists of:

- Serial cable customized and connected to the SNMP (max. cable length: 3 m)
- COM plug distributor cable (s. Figure 3)
- 230 V cable customized and connected to the SNMP

For connection of the SNMP Module to the RT-1000 system please take the following steps (for the wiring plan please s. Figure 4):

1. Connect the RS232 interface of the SNMP Module to RS232 interface of the RT-1000 (s. Figure 3).
2. Use the COM plug distributor cable for the connection of the RT-1000 Controller to:
 - The SNMP Module
 - Direction finder remote control system (DF Commander)

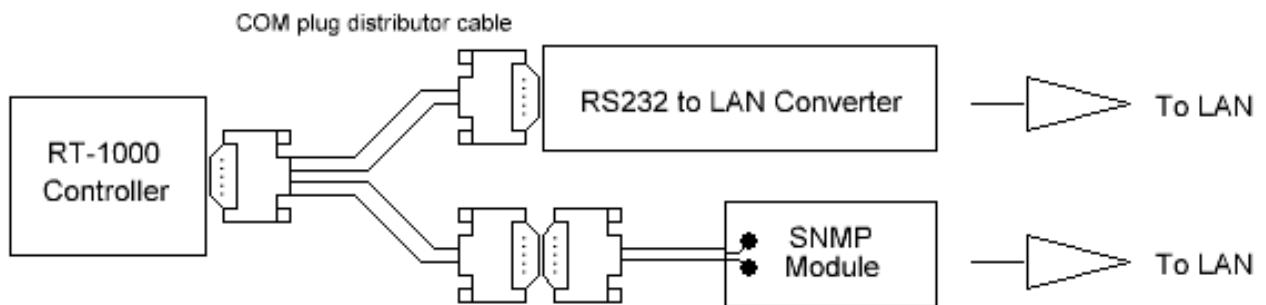

Figure 3: Connection of SNMP Module to RT-1000 system

4.2 Hardware Connection for Multichannel Mode

SNMP Module for RT-1000 Multichannel system is completely connected within the RT-1000 Multichannel rack before the delivery.

This also applies to the two channel systems in which both channels are arranged next to one another, except that the SNMP module is mounted on a rail.

For the wiring plan please refer to the following picture.

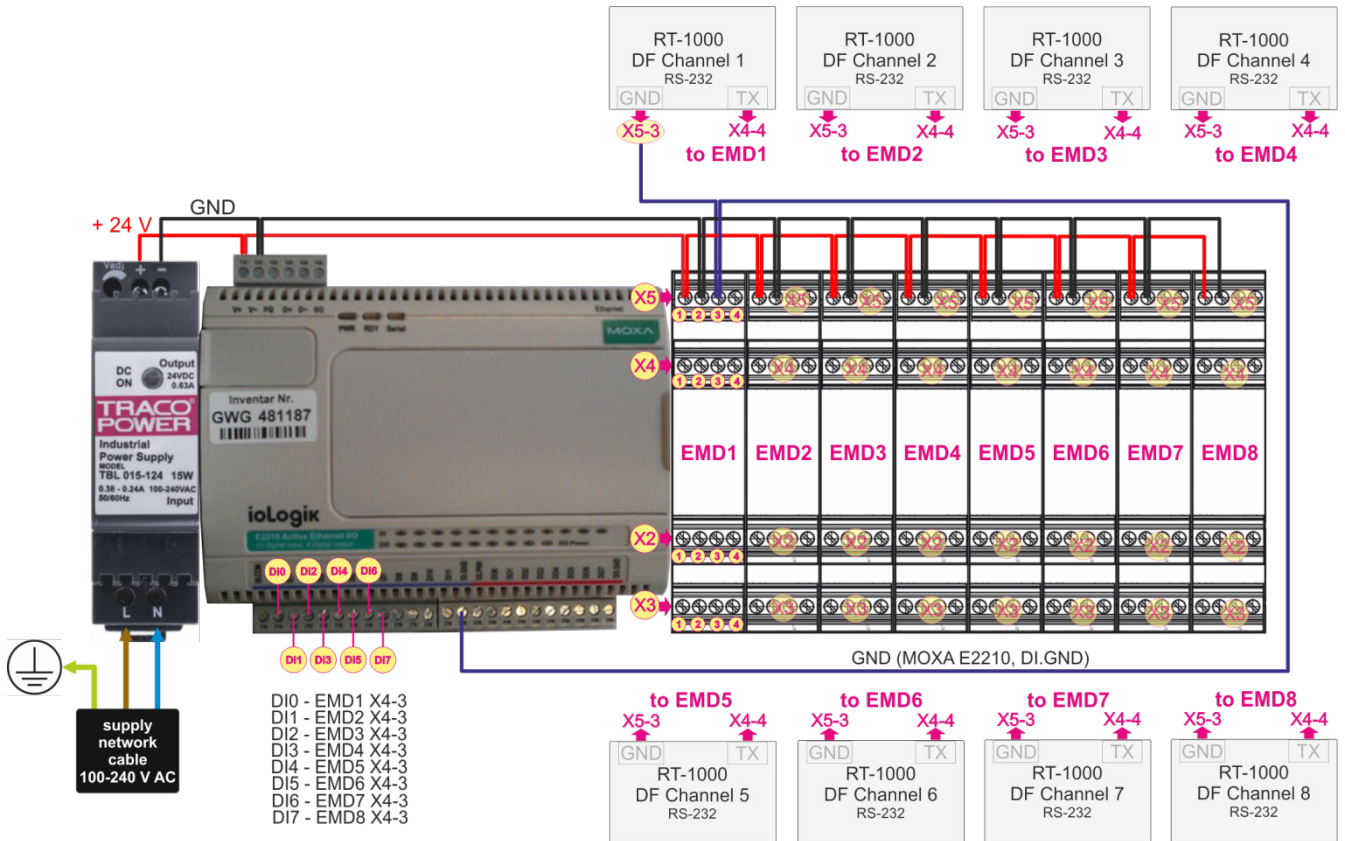

Figure 5: Wiring diagram for RT-1000 Multichannel

4.3 Interfaces

The interfaces of the EMD are four screw terminal connectors, which are mounted directly on the printed circuit board.



Figure 6: EMD screw terminal connectors

Connector	Pin Nr.	Name / Function One Channel Mode	Name / Function Multichannel Mode
X5	1	+ 24 V (Power Supply)	+ 24 V (Power Supply)
	2	GND (Power Supply and MOXA E2210 DI.GND)	GND (Power Supply)
	3	GND (RS-232)	GND (MOXA E2210 and RS-232 DF-Channel 1 ... 8)
	4	EMD RS-232-TX (optional)	EMD RS-232-TX (DF-Channel 1 ... 8)
X4	1	OUT ERROR 9	-
	2	TIME-OUT ERROR	-
	3	EMD ERROR (Self Error Detection)	OUT ERROR (Channel 1 ... 8)
	4	EMD RS-232-RX	EMD RS-232-RX (DF- Channel 1 ... 8)
X2	1	OUT ERROR 5	-
	2	OUT ERROR 6	-
	3	OUT ERROR 7	-
	4	OUT ERROR 8	-
X3	1	OUT ERROR 1	-
	2	OUT ERROR 2	-
	3	OUT ERROR 3	-
	4	OUT ERROR 4	-

For the wiring diagram please refer to chapter 4.1.

4.4 Software Installation and Configuration

Caution

Settings used in the following configuration description are explained by an example configuration. Please contact your network administrator for the correct settings specified to your network system.

There are configuration steps, which are mandatory.

Nevertheless the user is largely free to configure the module as it fits to the local SNMP monitoring system.

For detailed explanations about MOXA iLogik E2210 configuration options please refer to the manufacturer's user manual.

4.4.1 Mandatory Configuration

1. The default IP address is 192.168.127.254 and should be changed according to your network specification.

Connect to MOXA E2210 by entering the IP address into the internet browser.

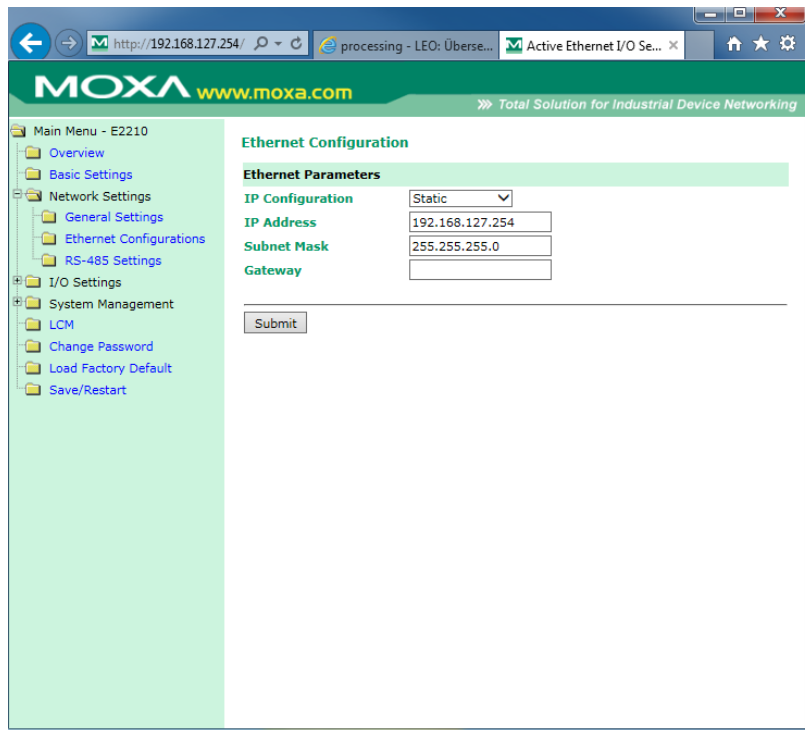

Figure 7: Web screen of MOXA E2210

- The assignment of a static IP address is recommended (no DHCP). Please configure the Ethernet parameters (IP Address, Subnet Mask, Gateway) under “Ethernet Configuration”.

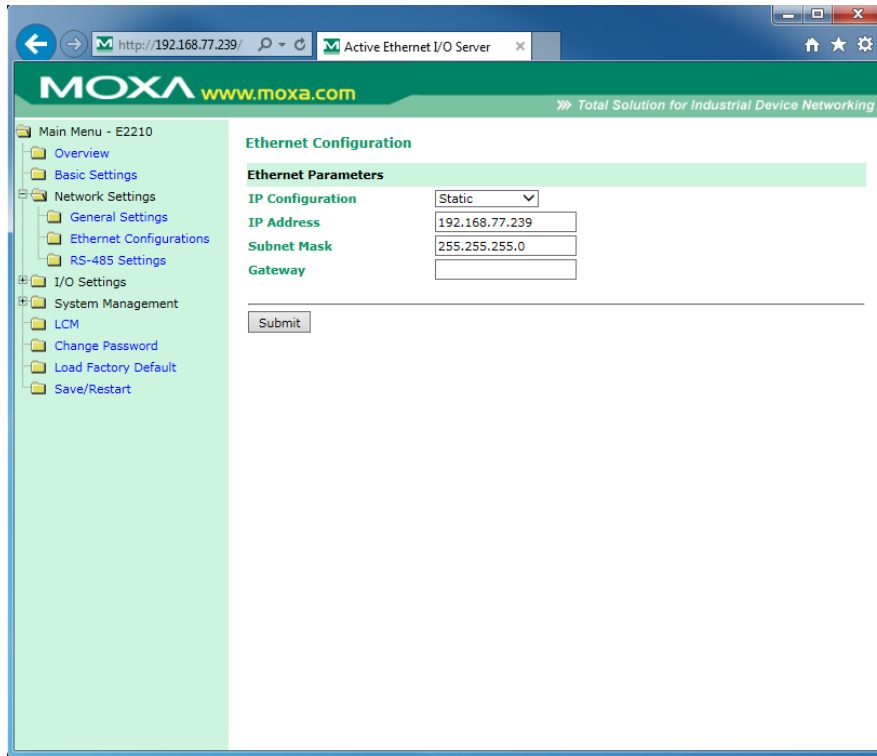

Figure 8: Changing the IP address under “Ethernet Configurations”

Please configure the DNS server under “General Settings”.



Figure 9: General Settings page

3. After all necessary settings have been entered, click on “Submit” and then on “Save / Restart”. After the restart MOXA E2210 device can be reached under the new IP address.

Caution

Each time the “Save / Restart” is pressed, the restart of the device will be executed. The device will be not available for approximately 12 sec. This can lead to an error message in the system.

4. For the configuration of the MOXA ioLogic E2210 device (SNMP Traps or other desired error notifications) the “ioAdmin” software is recommended. Please download the “ioAdmin” over the www.moxa.com page and run the executable file (ioAdminSetup.msi).

Follow the installation steps:

- Select the installation folder and click “Next”.

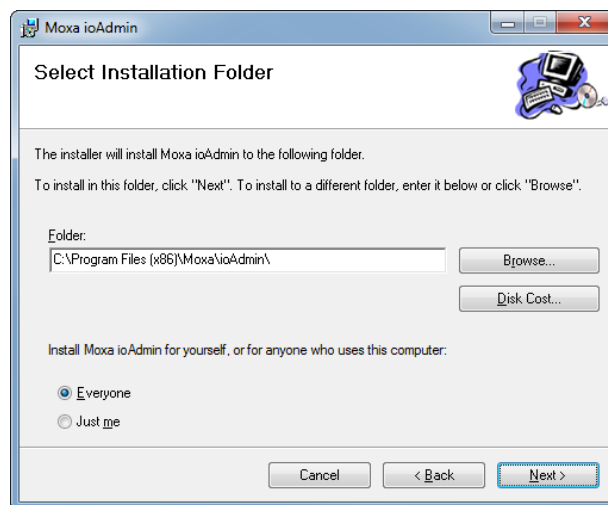

Figure 10: Installation ioAdmin, step 1

- Confirm the installation.

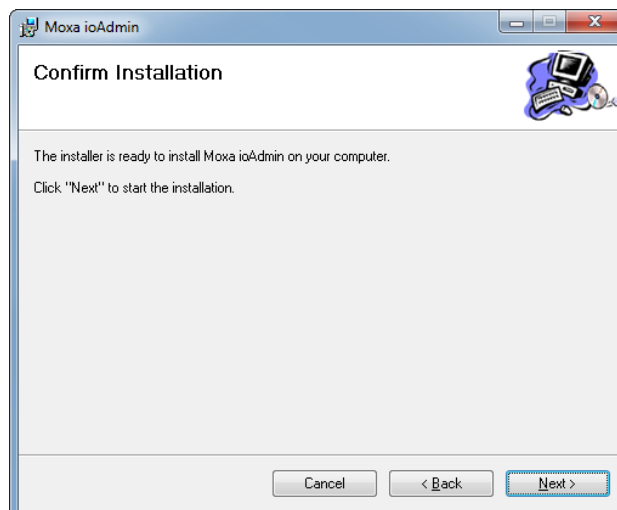

Figure 11: Installation ioAdmin, step 2

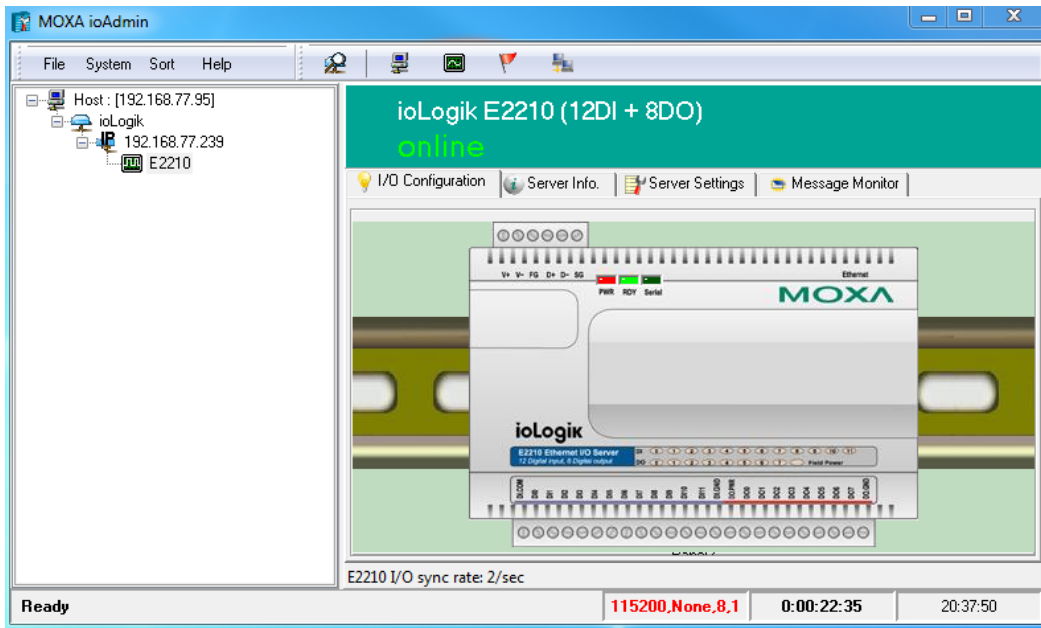

Figure 14: Start screen of the MOXA ioAdmin

7. Select “Server Settings” tab and click the “Login” button to log in as administrator. This is required in order to gain access to the ioLogik E2210 configuration options. For the first access no administrator password is needed (leave the password field blank). After the first access you can configure an administrator password for further accesses.

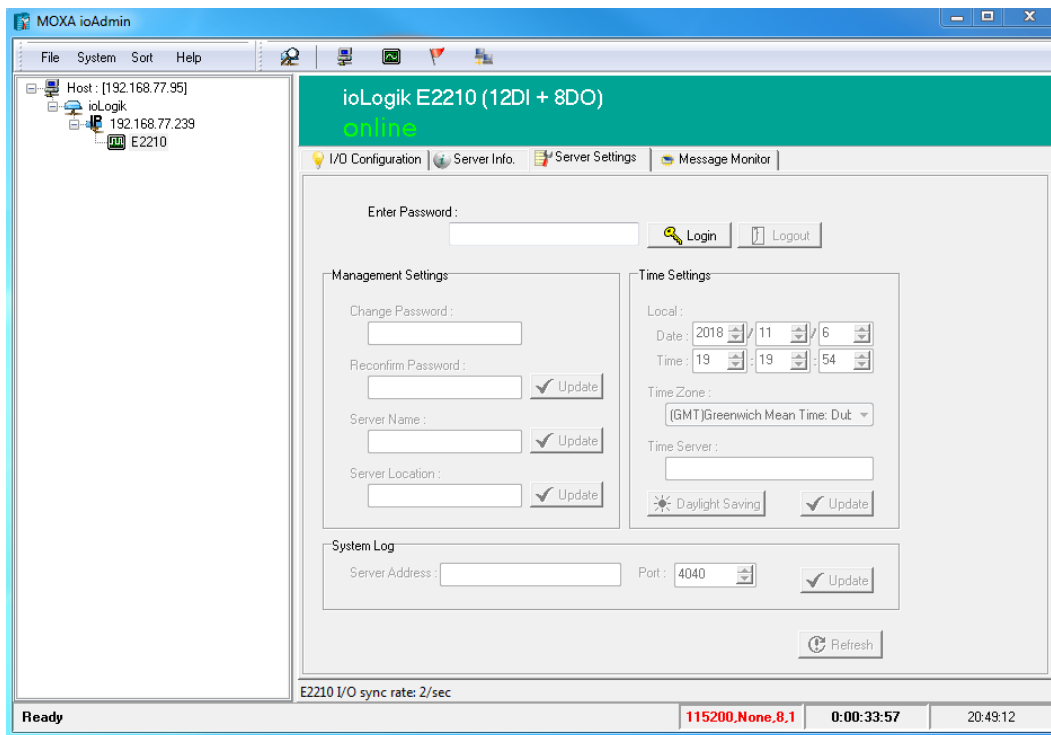

Figure 15: Server Settings page

Following window appears.
The device can be configured now.

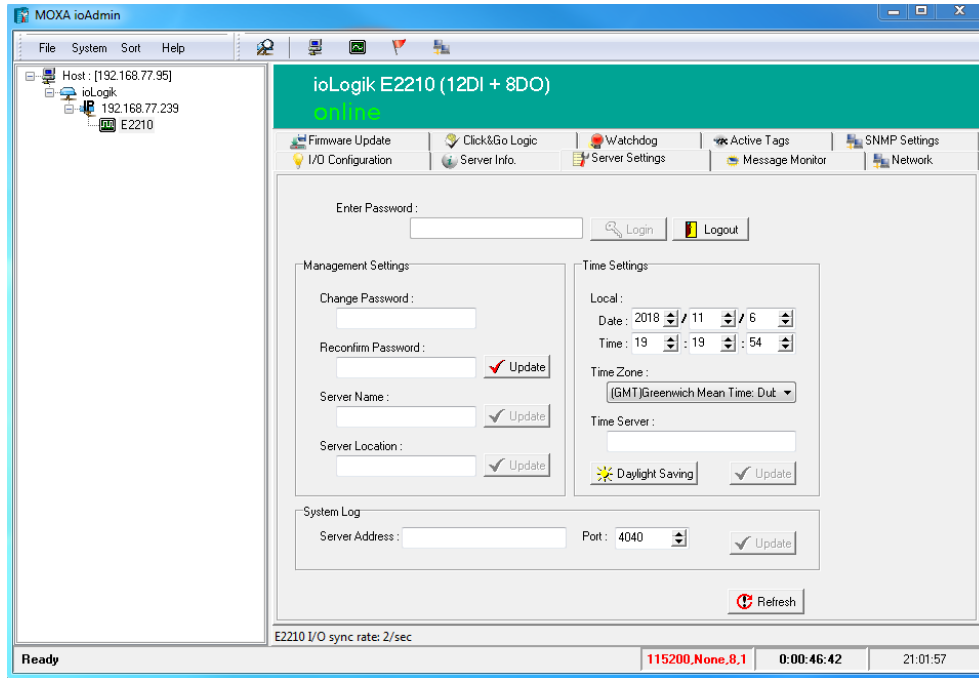

Figure 16: The administrator view with more configuration tabs

8. Select the tab “SNMP Settings”.
9. Select versions “V1, V2c, V3” over the drop-down menu in the “Global Setting” field.
10. Make your desired settings and passwords in the dialog fields.

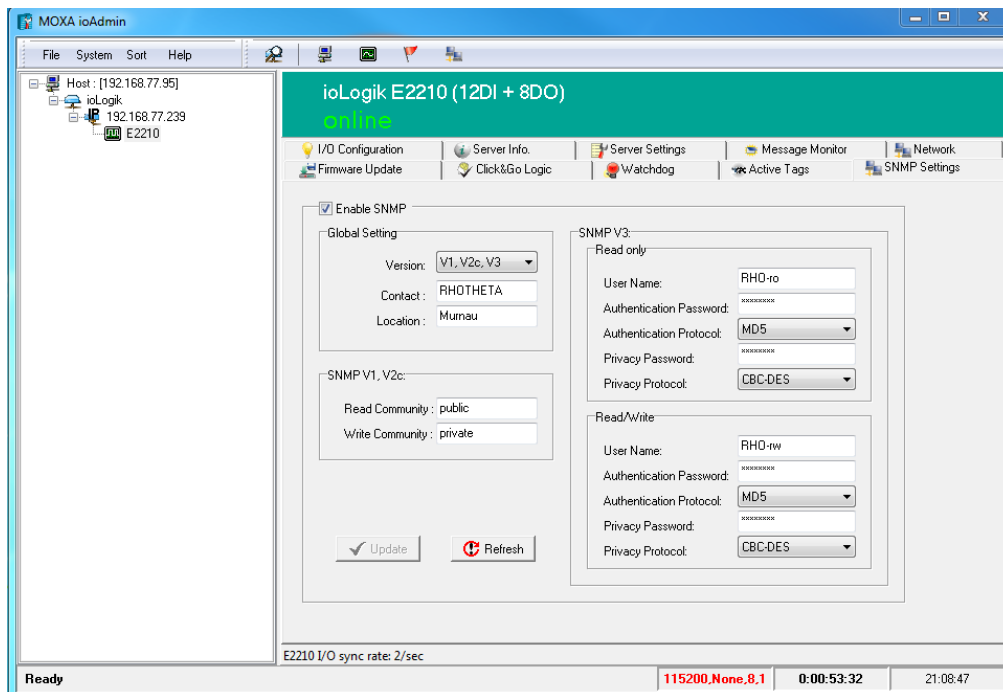

Figure 17: SNMP Settings page

11. Click on “Update”
Restart is required. Please accept the restart in the pop-up window.

Caution

Configuration changes lead to the restart of the module.
The device will be unreachable for about 12 seconds. This can lead to an error message in the system.

12. After the restart you will have to log in at “Server Settings” again and select the tab “Click&Go Logic”. Register settings, switching values and SNMP Traps are defined here.

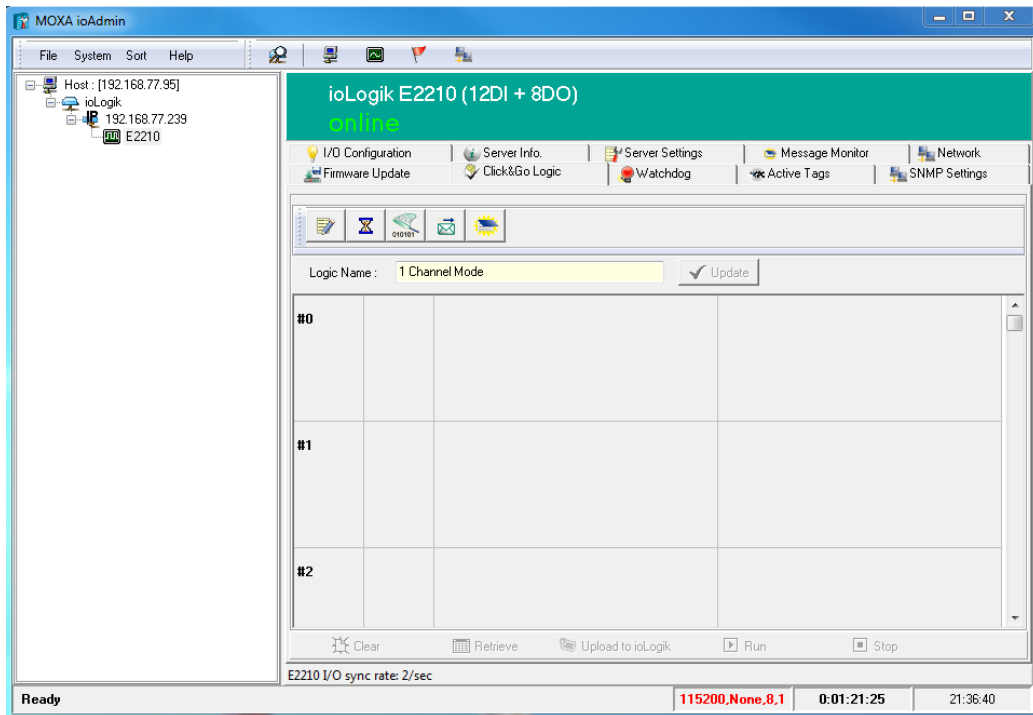

Figure 18: Click&Go Logic page

13. The SNMP Trap ID should represent the error number. For the description of how to do this setting please refer to the I/O configuration example (s. chapter 4.4.2). The table below contains the mandatory configuration of the SNMP Trap IDs.

Mandatory Configuration of the SNMP			
RT-1000 Error Number (Description)	EMD LED	MOXA ioLogik E2210 Digital Input (DI)	SNMP Trap ID
Error 1 (Processor)	1	DI7	1
Error 2 (EPROM)	2	DI8	2
Error 3 (RAM)	3	DI9	3
Error 4 (Power Supply)	4	DI10	4
Error 5 (EEPROM)	5	DI3	5
Error 6 (Synchronisation)	6	DI4	6
Error 7 (Phase Measurement)	7	DI5	7
Error 8 (Data Transfer or Power Supply of the Receiver)	8	DI6	8
Error 9 (Receiver Control)	9	DI0	9
Timeout Error (Data Transfer between SNMP Module and RT-1000)	10	DI1	10
EMD Error (EMD Failure)	-	DI2	11

Table 1: Mandatory Configuration of the SNMP

For RHOTHETA internal configuration files as configuration examples (One Channel Mode configuration file or Multichannel Mode configuration file), if needed, please contact RHOTHETA Elektronik GmbH. The test example (s. Appendix, 8.1) explains how to upload the existing configuration file into the MOXA E2210 module. In the chapter 4.4.2, step 29 is explained, how to create the own configuration file.

4.4.2 I/O Configuration Example

The logic of the individual I/O and the error response can be configured as it fits into your existing SNMP system (except the mandatory configuration of the SNMP Trap IDs and error numbers, s. Table 1 on page 17).

By double clicking on the numbered line (beginning with # sign), the logic configuration for the explicit digital I/O can be done:

1. Set the tick into "Enable" field to enable the I/O logic.
2. Select the "DI" (DI stands for digital input) in the first "<Empty>" drop-down menu in the "IF" field.

Figure 19: Enable the I/O logic

3. Click on the editing sign



4. Select the “DI-0” and “OFF to ON” in the appropriate drop-down menus and save this setting with “OK”. With this setting the SNMP Trap will be sent at each change of the error status (from “no-error-state” to “error-state”).

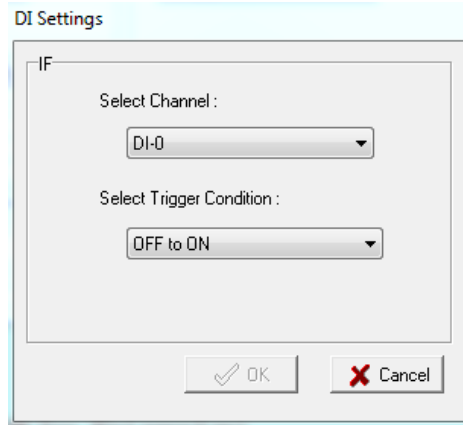



Figure 20: IF logic setup

5. Select the “SNMP Trap” in the first “<Empty>” drop-down menu in the “THEN” field (s. Figure 19).
6. Click on the editing sign 
7. Select the specific ID number for the SNMP Trap according to your SNMP monitoring system in the drop-down menu. If you want to send the text message additionally to the SNMP Trap ID, set the tick into the field “Bind Message” and tip your desired message into the text field. Save the setting with “OK”.

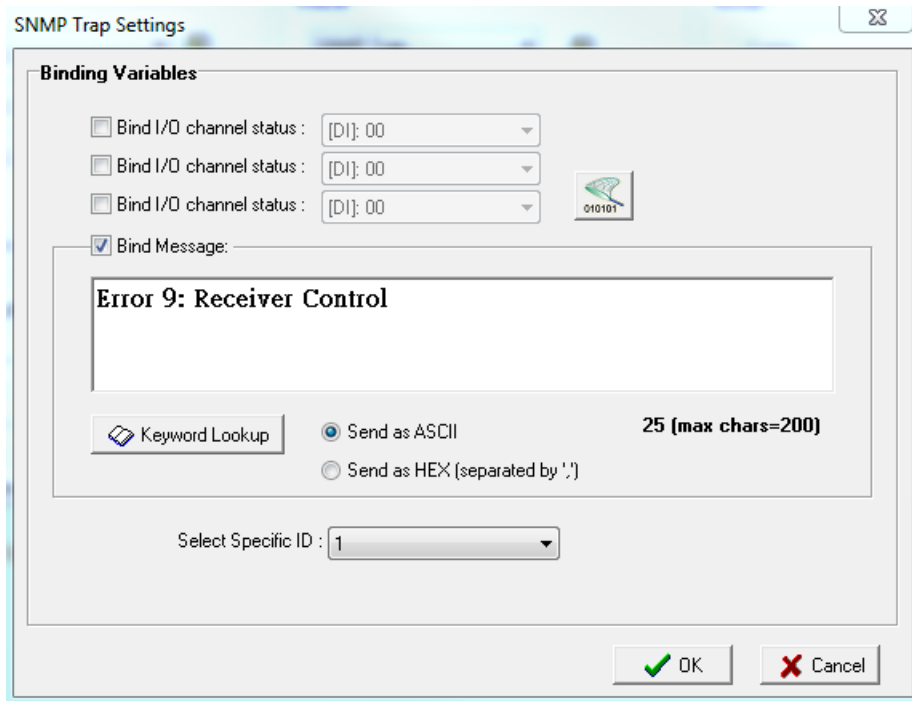



Figure 21: SNMP Trap Settings

8. Select „Remote Action“ in the drop-down menu of the second <Empty> button of the “THEN” field to set the repetition rate of the SNMP Trap if desired.

9. Click on the editing sign  and enter the repetition rate at “Send every...sec.” (a zero in this field will cause one single trap after reaching the “IF” condition) or the defined amount of SNMP Traps within a certain time interval, if desired. Save the setting with “OK”.

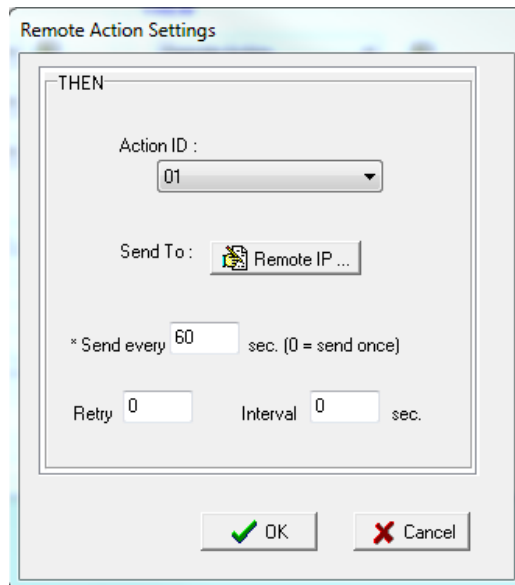



Figure 22: SNMP Trap repetition settings

10. Enter the desktop IP of the connected workstations, which should receive the SNMP Traps, either for each I/O separately (s. Figure 23) or over SNMP Trap Server button  above the “Logic Configuration” field (s. Figure 24).

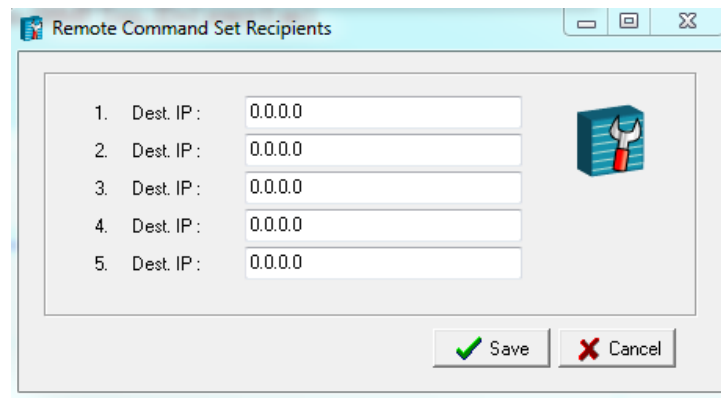

Figure 23: Desktop IP Settings

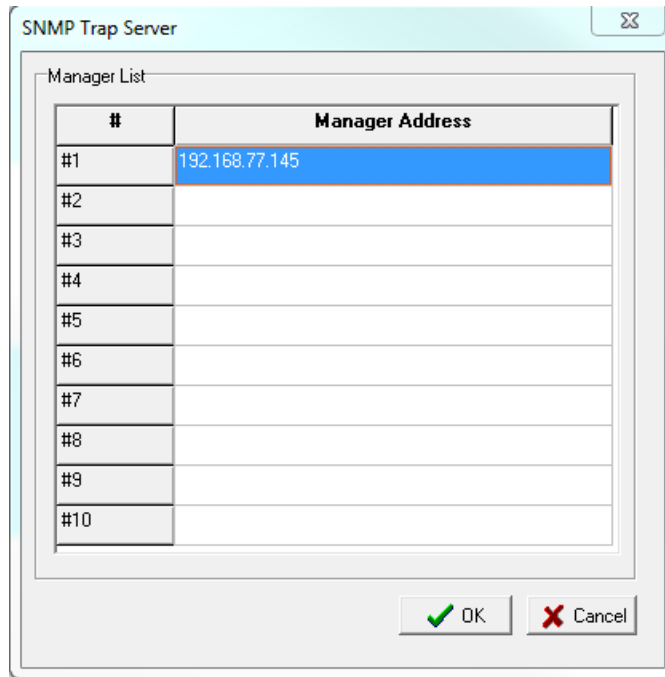

Figure 24: Set the SNMP Trap Server

The overview of the adjusted logic is then visible in the green field within the “Logic #0 Configuration” (s. Figure 25). Save the setting with “OK”.

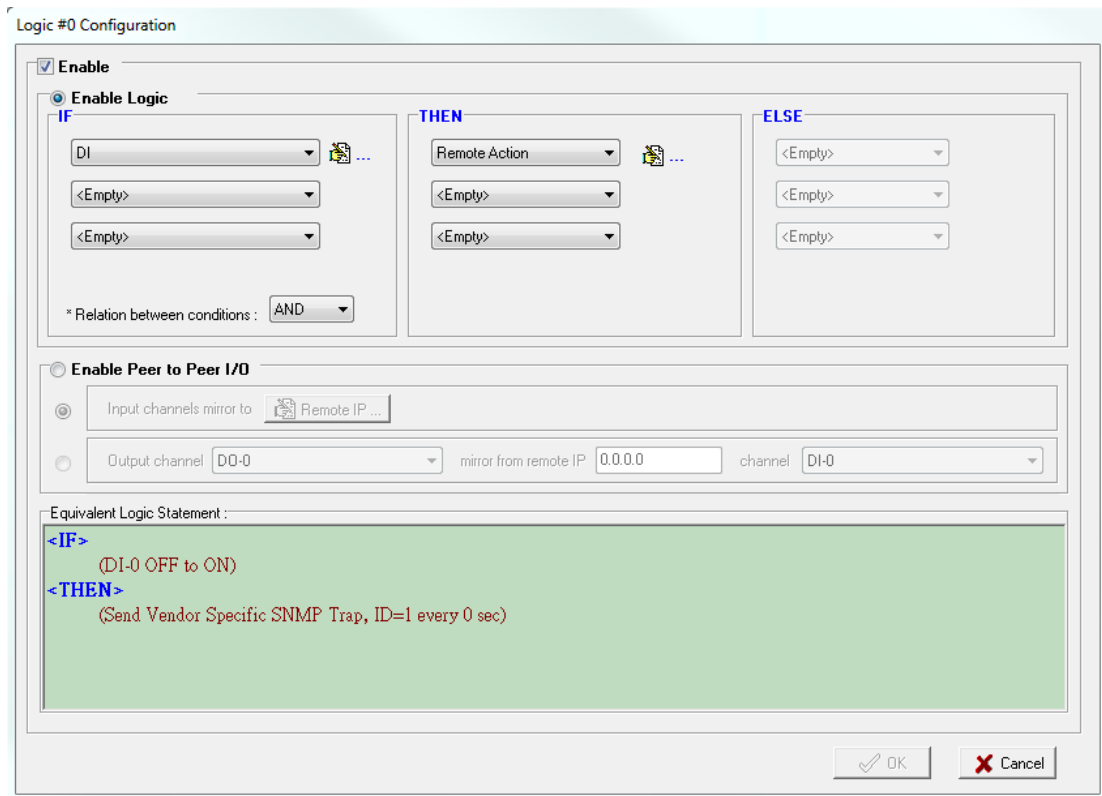

Figure 25: IF-THEN Configuration window

- After all needed I/O settings are completed, enter the “Logic Name” for this configuration (e.g. “One Channel Mode” for 11 error states (11 I/Os)).

For RHOTHETA internal configuration files as configuration examples (One Channel Mode configuration file or Multichannel Mode configuration file), if needed, please contact RHOTHETA Elektronik GmbH.

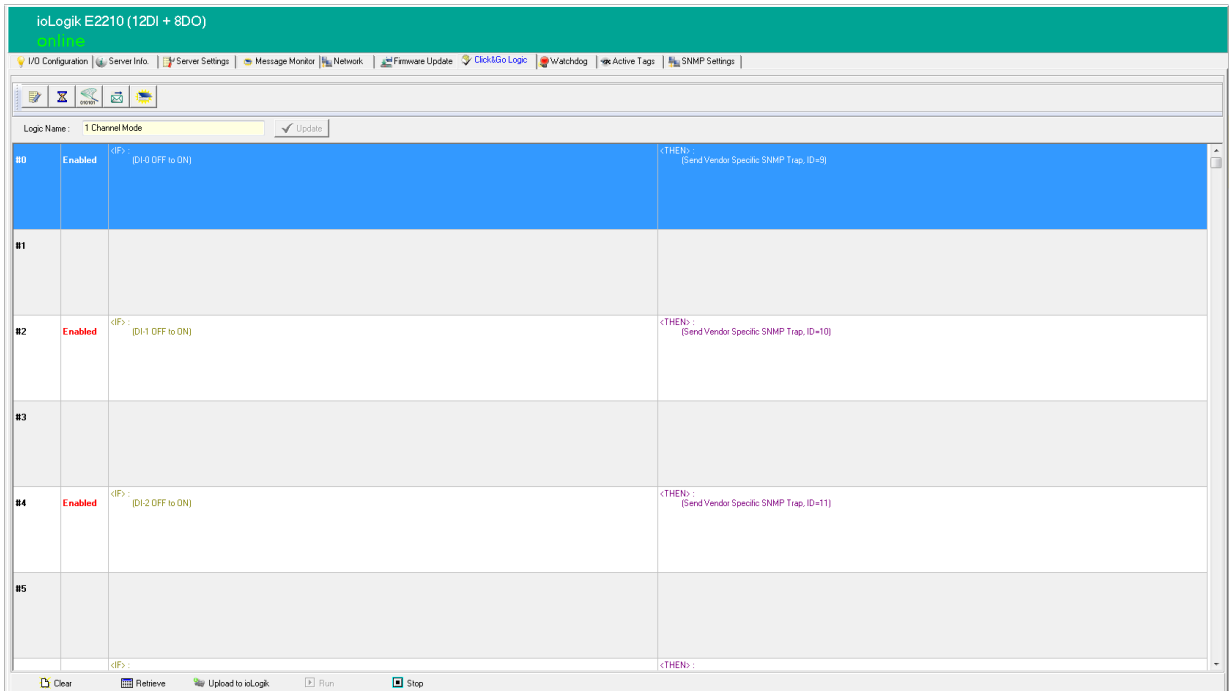

Figure 26: One Channel Mode Logic Configuration

12. When the “Click&Go” logic settings are complete, click on “Upload to ioLogic” in the lower control elements bar.

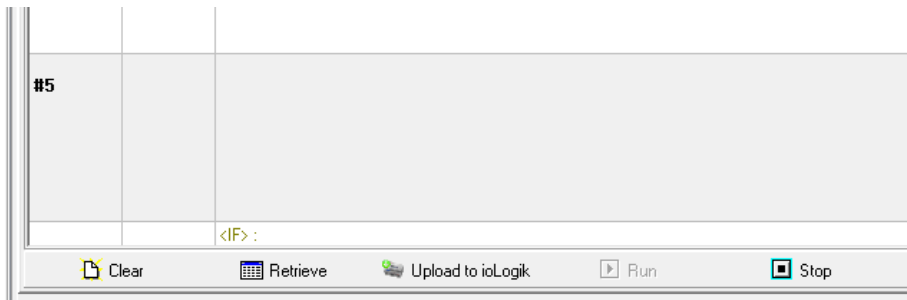

Figure 27: Upload to Logic

13. Confirm the request to restart the module.

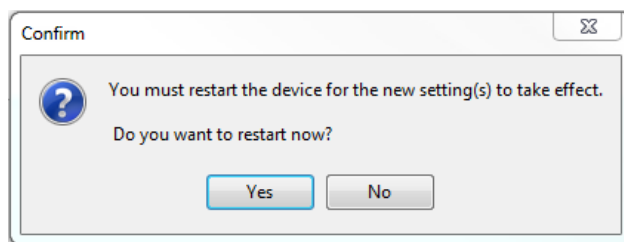

Figure 28: Request to restart the device

14. You can save the settings script (configuration file) to your PC and upload it to your MOXA E2210 module.
Therefore click with the right mouse key on the “E2210” symbol. Then select the download folder and save the script file.

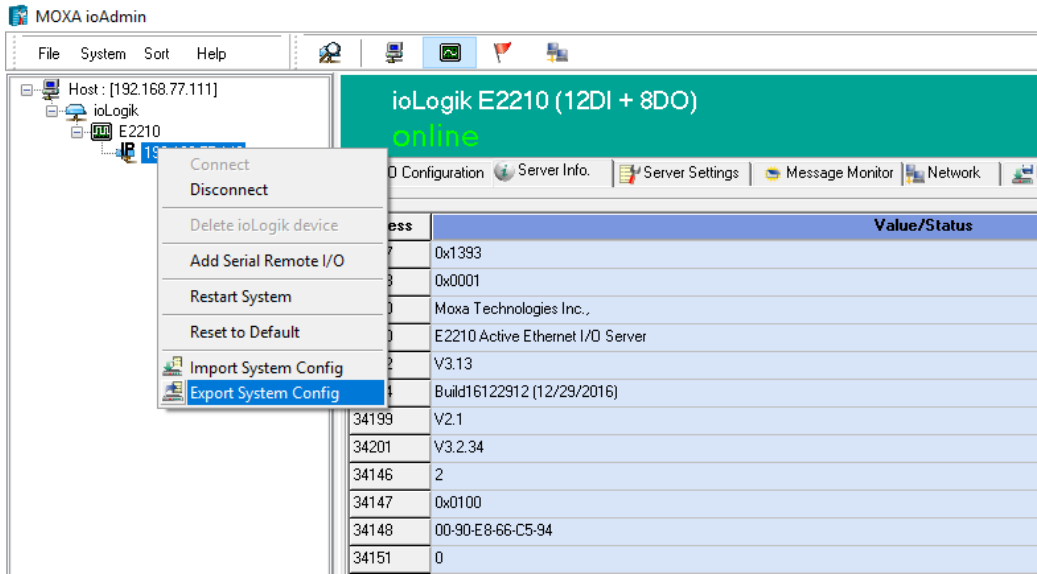

Figure 29: Doing backup of the module with scripts

For a test example with the configured logic refer to the chapter 8.1.

5 Operation

The SNMP Module is developed for the operation with all RHOTHETA RT-1000 direction finder systems:

- One channel system (RT-1000 A or RT-1000 C with one Controller Unit)
- Multichannel system (RT-1000 Multichannel or RT-1000 C with two Controller Units)

The operation modes can be switched via jumper on the EMD module (s. Figure 30).

If the jumper X6 is mounted, SNMP Module works in the “Multichannel Mode”. By taking the jumper X6 off the “One Channel Mode” will be activated (s. Figure 30).

5.1 One Channel Mode

During the operation of the SNMP Module in One Channel Mode the errors are indicated on the EMD device via LEDs in addition to the SNMP traps.

If an error occurs, one of the LEDs of the EMD module lights up in red color. Each error state is indicated by one LED (s. Figure 30).

The green LED inside the EMD box indicates, that power of the EMD module is on.

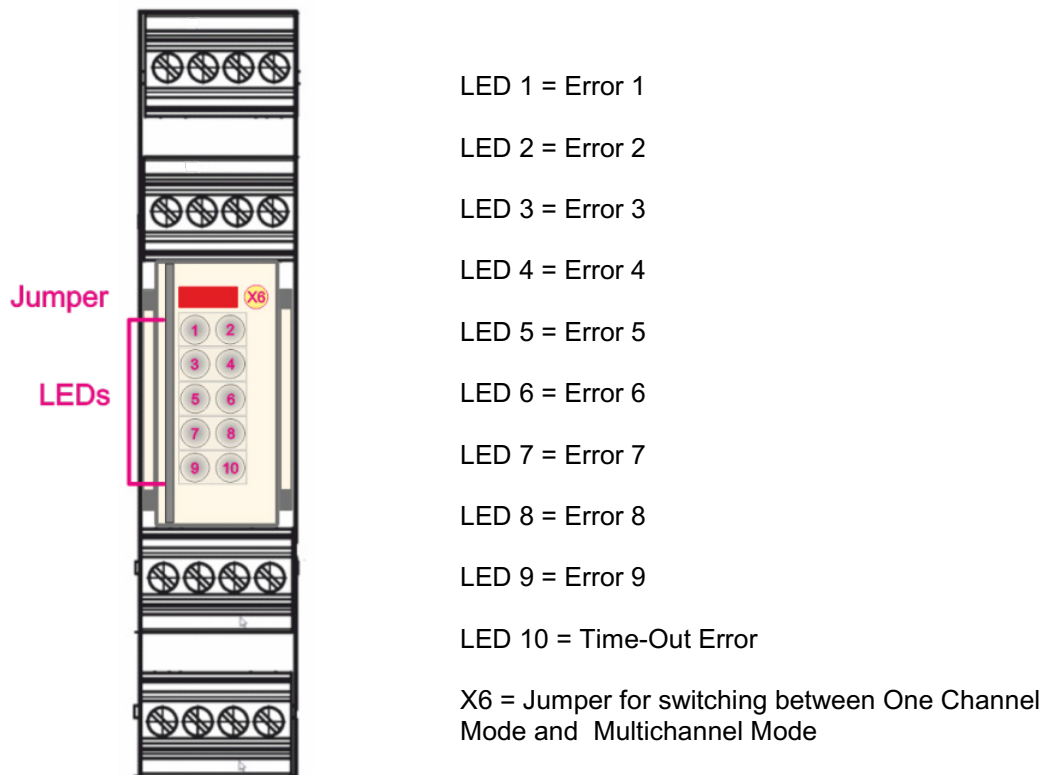

Figure 30: Error Indication via LEDs of the EMD Module

If neither error LED nor the green power indication LED are on, the EMD module itself is either defective or not connected to the power.

For error descriptions refer to the chapter 4.4.1, table “Mandatory Configuration of the SNMP”.

5.2 Multichannel Mode

If an error occurs during the operation of the SNMP Module in Multichannel Mode, the LEDs of the EMD module will not light up.

The errors are then indicated by the SNMP Traps or appropriate MOXA ioLogic E2210 LEDs (according to the wiring diagram, s. Figure 5). This will be a basic error state report (“No-Go”).

In this it is indicated which of the connected channels reports an error, but not the explicit error information (error number).

6 Technical Characteristics

Electrical Characteristics

Parameter	Data
Input Voltage	230 V AC
Current Consumption	70 mA AC (max.)

Mechanical Characteristics

Parameter	Data
Max. External Dimensions (Mounting on the Rack)	168 mm x 110 mm x 70 mm
Max. External Dimensions (Mounting in the Box)	250 mm x 200 mm x 122 mm
Weight (Mounting on the Rack)	< 0,6 kg
Weight (Mounting in the Box)	< 1,5 kg

Environmental Characteristics

Parameter	Data
Operating Temperature	-20°C to 60°C
Storage Temperature	-40°C to 70°C
Humidity	10% RH to 90% RH, noncondensing
Maximum Altitude	2000 m

7 Legal Information

7.1 EU Declaration of Conformity

The SNMP Module complies to EMC standards for industrial environments.

Hereby, RHOTHETA Elektronik GmbH declares that the product SNMP Module is in compliance with the essential requirements to be put on the market, and with other relevant provisions:

- Directive 2014/30/EU relating to electromagnetic compatibility
- Directive 2014/35/EU relating to electrical equipment designed for use within certain voltage limits
- Directive 2011/65/EU on the restriction of the use of certain hazardous substances in electrical and electronic equipment.

A copy of the EU declaration of conformity is available at <http://www.rhotheta.com/>

7.2 Disposal within the European Union

Product Recycling



■ Product labeling in accordance with EN 50419

At the end of the life of the product, this product may not be disposed of with normal household waste. Even disposal via the municipal collection points for electrical and electronic equipment is not allowed.

The correct disposal of this product will help to conserve resources and prevent potential negative effects on the environment and human health which may occur due to improper handling of the product.

- Therefore, carry out the inoperative device an electronics recycling.
- RHOTHETA Elektronik GmbH takes back all its products, subject to redemption, in accordance with the requirements of the WEEE Directive (2012/19/EU) of the European Union to deliver it to a professional disposal.

7.3 Disposal outside the European Union

For proper disposal of used electronic equipment in accordance with the respective national regulations in countries outside the European Union please check it with your dealer or the local authorities.

8 Appendix

8.1 Test Example

This is an example for the examination of the SNMP Module function.

Hardware used in this test:

- RT-1000 Direction Finder System
- SNMP Module

Software used in this test:

- SNMP monitoring software (MOXA MX View)
- SNMP configuration software (MOXA ioAdmin)

Precondition for the test:

- RT-1000 System is installed and working.
- SNMP is appropriately configured and connected as it is described in previous chapters. Ensure that the correct IP address of the PC used for the test is adjusted in the “Click&Go Logic” of the MOXA E2210 Module (refer to chapter 4.4.2).
- “MX View” is installed and configured

If MX View is not yet installed, please download and install the software on the test PC. Following configuration steps are required:

- Start the “MX View” application.
Following window appears.
Click on “Start” button and then on “Launch Client” button.

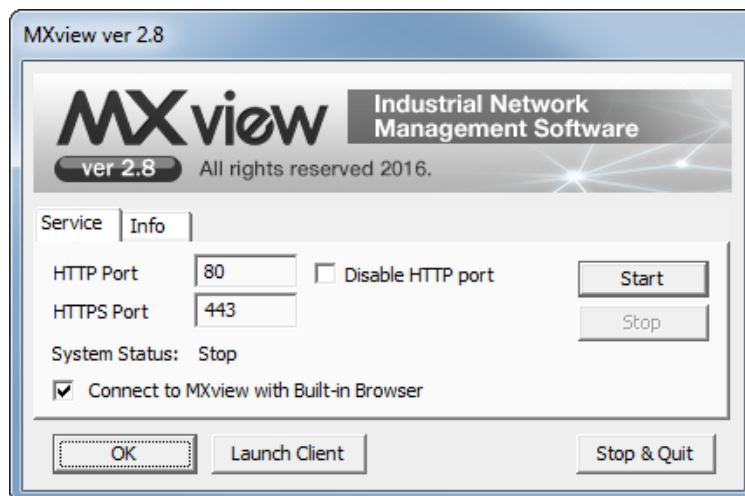

Figure 31: Starting MX View application

- A web page for “MX View” opens automatically.
Log in with:
Username: admin
Password: moxa



Figure 32: Log in at MX View web page

- If you run the “MX View” for the first time you may be offered to use the “Setup Wizard”. In this case click on “Cancel” and add the device manually. The request for changing the password can be ignored as well.
- In the menu “Project” select the option “Add Device”.
- Enter the IP address of the MOXA E2210 Module into the “IP address” line and click on “Add”.

Figure 33: Adding the MOXA E2210 module for monitoring

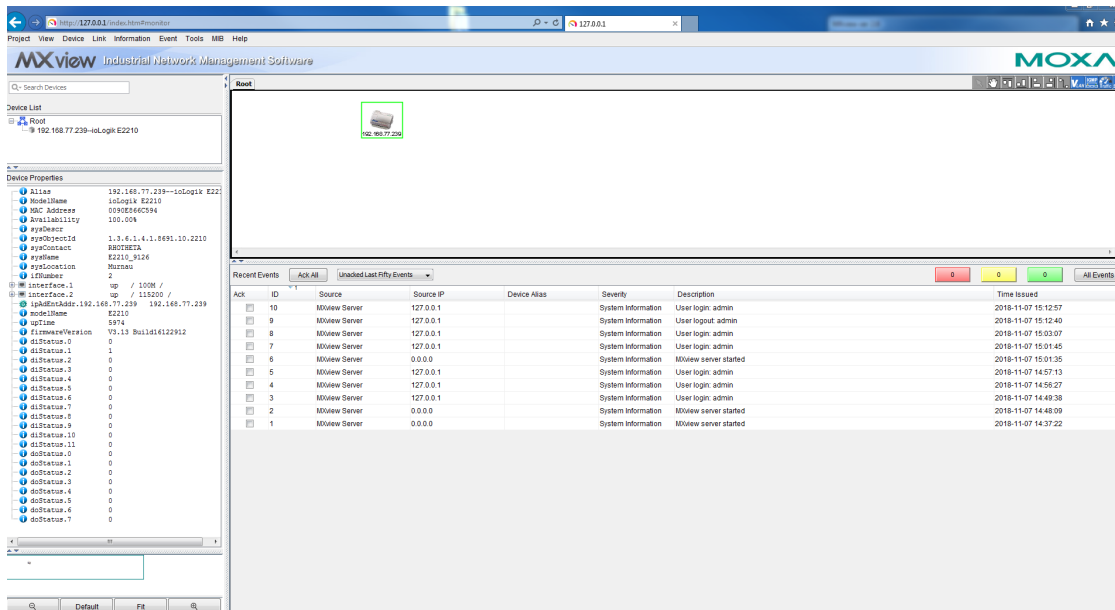

Figure 34: MX View monitoring page

- In the Device List (left docking window) the connected MOXA Module with its properties is visible.
- In the “Root” area the MOXA E2210 device is visible as an icon.
- Below the “Root” area there is the “Recent Events” area, where actual SNMP messages or other events are displayed (e.g. log-in-events or Device reachability of MOXA E2210 module).

After the connection between SNMP Module and “MX View” as well as the connection between RT-1000 System and “DF Commander” (remote control) are established, the actual test can begin.

Test steps:

1. Disconnect RS232-line between RT-1000 System and SNMP Module.
2. EMD Error LED10 should light up .
3. Appropriate SNMP Trap (“specific: 10”) should appear in the “Recent Events” list of the “MX View” application.

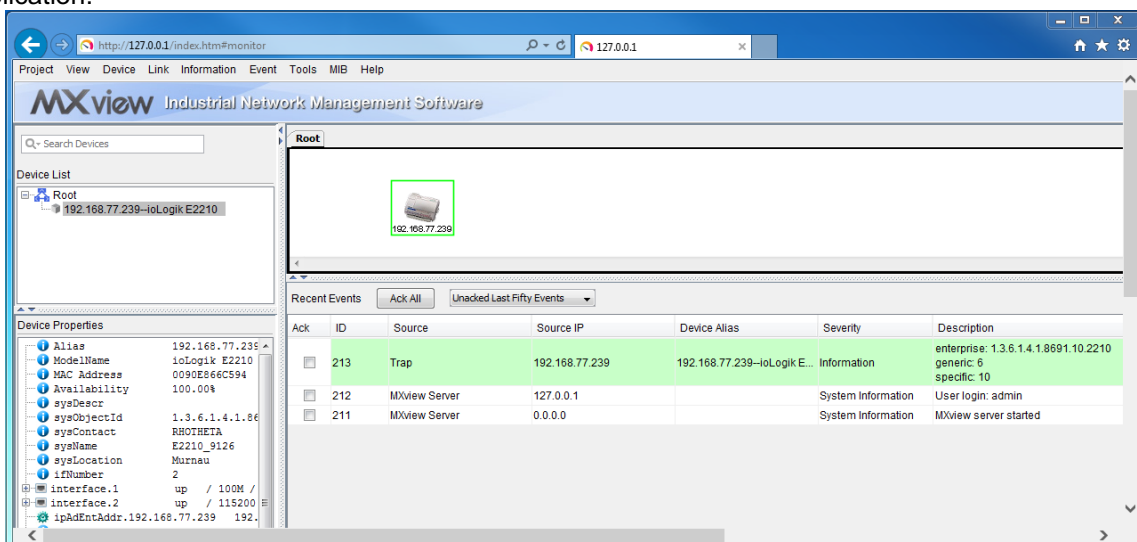

Figure 35: SNMP Trap ID 10 standing for timeout error

4. Establish the RS232 connection again.
5. EMD Error LED10 should turn off.
6. If you configured the SNMP Trap for “No Error” state, then it should appear under “Recent Events”. If no SNMP Trap is intended for “No Error” state, nothing should appear under the “Recent Events”.

9 Notes